

1. Start Guide

1.1 Accessories

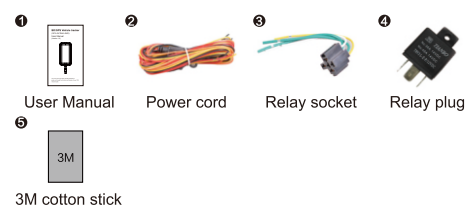

1.2 Main Features

- WCDMA & GSM
- 9-90V working voltage
- Vehicle battery protection
- ACC detection for ignition status
- IP65 waterproof
- Remote cut-off (petrol/power)
- Multiple alarms

1.3 Specifications

Communication system	GSM: 850/900/1800/1900 MHz WCDMA: 850/900/1900/2100 MHz
GPS chipset	Ublox-M8130
Location accuracy	< 10 meters
TTFF (open sky)	Avg. hot start ≤1sec Avg. cold start ≤32sec
Battery	400mAh/3.7V
Working voltage/current	9-90VDC/31mA(12VDC),19mA(24VDC)
Dimension	88(L)*45(W)*13(H)mm
Weight	60g

2. My device

2.1 Appearance

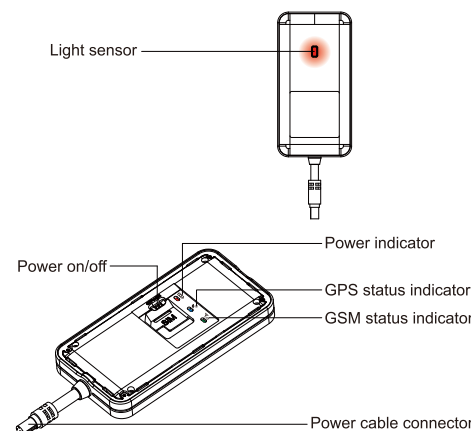

2.2 LED indicators

GPS LED Indicator - Blue	
Flashing (interval 0.1s)	Searching BD/GPS signal
Solid blue	BD/GPS positioned
OFF	GPS sleep or off

GSM LED Indicator - Green	
Quick flashing	GSM initializing
Slow flashing	Receive GSM signal normally
Solid green	Connected to GPRS network
OFF	No GSM signal or SIM card

Power Status - Red	
Flashing	Low battery
Slow flashing	Full charge/Work normally
Solid Red	Charging
OFF	Low battery/Power off

3. Installation

3.1 Installation position

Considering the technicism of GPS tracking devices, assistance from professional services is recommended.

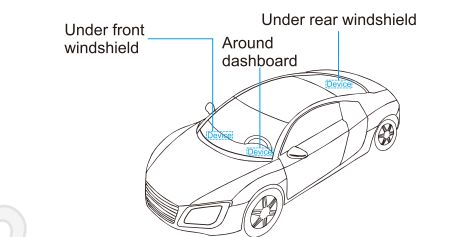

- Please install the device upwards (LED indicators facing upward).
- If the windshield has been pasted by lagging and heating, GPS signals will be weakened, which may result in abnormal GPS work, so please change GPS tracker installation position.

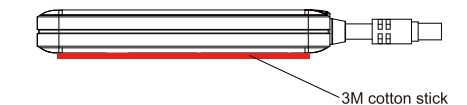

3.2 Wiring configuration

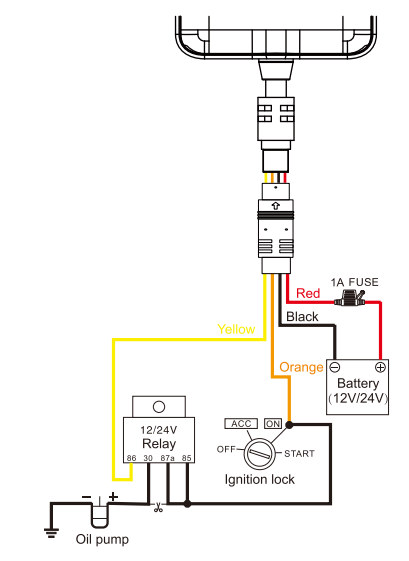

- The working voltage ranges from 9-90V. The device can be applied to 12V, 24V, 36V, 48V and 72V vehicles. Please use the power cord from original factory. Red line means positive side while black line means negative side. During installation, negative side should connect to the ground.
- ACC line (orange) connects to vehicle's ACC, detecting ignition and flameout.
- Device's oil and electricity control line (yellow) connects to relay's 86. (thin yellow line of relay socket)

4. Install the SIM card

- Note:**
- Please power off the device before install or remove the SIM card.

- Open the cover

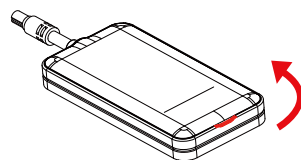

- Insert the SIM card correctly

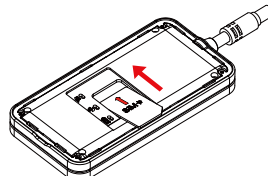

5. Operation of device

5.1 Power on

Remove the cover, turn on battery (switch is in ON position, internal power starts and device power on. The internal power is used when external power is cut off) and connect the external power, you will see power indicator lights up and begin to supply power.

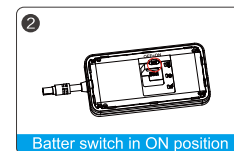

5.2 Power off

To power off the device, cut off external power first and remove the front cover to move the battery switch to OFF. Power indicator is OFF and battery charging stops the moment device turned off.

6. APP/Platform operation

Get registered on the designated service platform by authorized dealer, then you can start the tracking service and settings.

6.1 Login service platform

Please login the designated service platform to set and operate the device.

6.2 Download APP

Please download and install the APP in designated website.



7. Main Functions

7.1 Power cut-off alert

When the electricity supply of device is cut off, it will activate cut-off alarm. (Battery switch should be in ON position)

7.2 Low battery alert

When battery is low, the device will activate low battery alarm. Alert message will be uploaded to backstage (if this function is activated by APP or platform).

7.3 Displacement alert (Default OFF)

Device will send movement alarm when vehicle moves out the pre-set distance (when ACC is off and GPS is fixed).

7.4 Vibration alert (Default OFF)

When vehicle vibrates several times, the vibration alarm will be triggered. If no ignition after 3 minutes (ACC OFF), the device will send vibration alarm message immediately.

7.5 Tamper alert

When light sensor detects unauthorized displacement from the original installation, device will send alert to SOS number. Alert method from be SMS, CALL or GPRS. Defaulted method is GPRS.

7.6 Petrol/Power cut-off

When vehicle is stolen, oil/electricity cut-off command can be sent by platform or APP. To make sure the security of vehicle, tracker can only indicate to cut off oil when GPS is in valid position status, and the speed is less than 20KM/H.

Note:

- To cut off oil/electricity, please make sure the ACC line is correctly connected.
 - To ensure vehicle's safety, the device won't cut off oil/electricity only if a) BD/GPS is positioning b) vehicle is in static or its speed is less than 20KM/H.
- If above requirements can't be met, oil/electricity cut-off command will be delayed.

7.7 Restore petrol/power

When alarm is cancelled, user can send restore oil/electricity command by platform or APP and restore vehicle power.

Note:

To receive alert messages, pre-set SOS number is essential for functions mentioned above. Please log in the APP or Website to set.

8. Common Command List

Edit SMS command in the right column to the device SIM number to achieve respective function as below:

1	Device status	STATUS#
2	Device coordinate	WHERE#
3	Location URL	URL#
4	Check version	VERSION#
5	Network setting	GPRSSET#
6	APN setting	1. APN, apname# E.g: APN, internet# 2. APN, apname, user, pwd# E.g: APN, internet, CLIENTE, AMENA#
7	Server setting	SERVER, mode, domain/IP, port, 0# E.g. SERVER, 1, www.ydpat.com, 8011, 0# SERVER, 0, 211.154.135.113, 8011, 0# mode 1 means set with domain name mode 0 means set with ip address
8	SOS setting	1. Add SOS number: SOS, A, number 1, number 2, number 3# 2. Delete subjected sequence of SOS number: SOS, D, number sequence 1, number sequence 2, number sequence 3# E.g. SOS, D, 1, 2, 3# 3. Delete the SOS number: SOS, D, phone number# 4. Query SOS number: SOS#
9	GPS data upload time interval	TIMER, T1, T2# T1=5~18000 seconds; ACC ON upload interval; default value: 10 T2=5~18000 seconds; ACC OFF upload interval; default value: 10 (when GPS is not sleep)
10	GPS data upload distance interval	DISTANCE, D# D=0. 50~10000 meter; Distance interval; default value: 300, unit: meter
11	Delayed defense setting	DEFENSE, A# A:1~60 minutes, set delayed defense, default value: 10 minutes
12	Vibration alarm (default OFF)	1. SENALM, ON# 2. SENALM, OFF#

13	Displacement alarm setting (default OFF)	1. MOVING, ON, R, M# R=100~1000; Displacement radius, unit: meter M=0-2; Alert way 0: GPRS, 1: SMS+GPRS ; 2: GPRS+SMS+CALL E.g. MOVING, ON, 200, 2# 2. MOVING, OFF#
14	Set center number	Set center number: CENTER, A, mobile number# Delete center number: CENTER, D#
15	Power/oil control	RELAY, A# A=0/1 0= restore petrol; 1=cut off petrol Default value: 0 E.g. RELAY, 1#
16	Restart	RESET# Device restart 20 seconds after receiving this command

9. Trouble shooting

If you are having trouble with your device, try these troubleshooting procedures before contacting a service professional.

Problems	Causes	Solutions
Poor signal	The signal waves unable to transmit when use the GPS tracker in the places that have poor signal reception, such as: tall building around or basement.	Using the GPS tracker in the places that have good signal condition.
Unable to boot	Low battery	Charge the device battery

Unable to connect to the network	Poor signal	Using the GPS tracker in the places that have good signal condition.
Unable to locate	Signal shielded or Poor signal	Change the installation place
No power off alarm	Built-in battery is off	Turn it on
Fail to start the car	Power cutoff /ACC abnormal	Restore power/ Check ACC
Car stops driving	Abnormal power supply	Connect the device negative electrode to constant power
Offline/ Indicators off	Abnormal power supply/Indicators sleep	Check power supply/ Press side key to activate indicators
No update of vehicle's location	No GPS positioning	Test the device again/ Change installation place

Warranty instructions and service

- The warranty is valid only when the warranty card is properly completed, and upon presentation of the proof of purchase consisting of original invoice indicating the date of purchase, model and serial No. of the product. We reserve the right to refuse warranty if this information has been removed or changed after the original purchase of the product from the dealer.
- Our obligations are limited to repair of the defect or replacement the defective part or at its discretion replacement of the product itself.
- Warranty repairs must be carried out by our Authorized Service Centre. Warranty cover will be void, even if a repair has been attempted by any unauthorized service centre.
- Repair or replacement under the terms of this warranty does not provide right to extension or renewal of the warranty period.
- The warranty is not applicable to cases other than defects in material, design and workmanship.

Maintenance Record

Date	Serviced by
Product Model	
IMEI Number	
Fault Descriptions	
Comments	

3G GPS Vehicle tracker

User Manual

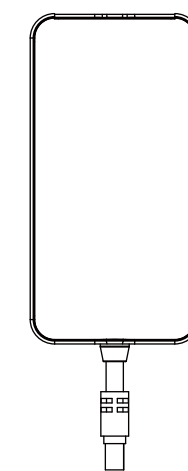

(Version 1.3)

Thanks for choosing our tracker. This user manual has been specially designed to guide you through the functions and use of your GPS vehicle tracker.

Warning: One side of the device is marked "this side up", place the unit upside down will result in connection issues. Avoid placing the device somewhere that metal will be covering it up.